

10 NOV. 1970



ICAS Paper No. 70-57

**DESIGN PROBLEMS AND SOLUTIONS FOR FIVE TYPES
OF LOW-DISC-LOADING, HIGH-SPEED VTOL AIRCRAFT**

by

Robert L. Lichten
Director of Advanced Engineering
Bell Helicopter Company
Forth Worth, Texas USA

The Seventh Congress of the International Council of the Aeronautical Sciences

CONSIGLIO NAZIONALE DELLE RICERCHE, ROMA, ITALY / SEPTEMBER 14-18, 1970

Price: 400 Lire

DESIGN PROBLEMS AND SOLUTIONS FOR FIVE TYPES OF
LOW-DISC-LOADING, HIGH-SPEED VTOL AIRCRAFT

Robert L. Lichten
Director of Advanced Engineering
Bell Helicopter Company
Fort Worth, Texas, U.S.A.

ABSTRACT

The solitary success of the helicopter among transport/utility VTOL aircraft types is based on its ability to lift an economical payload vertically and suggests that most future higher-speed VTOL machines will utilize low-disc-loading rotors in the vertical flight mode. For high-speed flight some form of variable geometry will be used to avoid helicopter limitations. Rotors can either be maintained in a horizontal plane or tilted forward to propeller position; in either case they are unloaded, and speed of rotation may be reduced and/or blades contracted, or they may be stopped and blades folded. Five specific configurations treated cover the addition of wings, compounding, variable-diameter, tilting, and tilting plus folding. Problems and solutions in dynamics, design, weight considerations and aerodynamics are discussed. It is concluded that all offer advantages for various VTOL applications, with economical cruise performance available from about 200 to 500 knots. Providing VTOL capability causes some penalty in weight and cost compared to equivalent airplanes in transport functions.

INTRODUCTION

Over the past 25 years, the low-disc-loading helicopter has been the only type of Vertical-Takeoff-and-Landing (VTOL) aircraft to attain broad acceptance for production and operational use, particularly in transport/utility roles where vertical lift of an economic payload is a prime requirement. The term "low-disc-loading" is used to denote takeoff-gross-weight loadings of the equivalent disc area of the vertical-lift-producing device of below 16 lbs/sq ft (78 kg/sq m), which is considered the upper limit for tolerable environment effects in unprepared areas and for reasonable vertical lifting efficiency.

Vertical Lifting Efficiency

The basic reason for the dominance of low-disc-loading VTOL aircraft is their superior vertical lifting efficiency, as illustrated in Figure 1. This shows the vertical lift per equivalent installed shaft horsepower (sufficient to provide hovering out-of-ground-effect at 6000 ft, 35°C) for typical gas turbine engines.

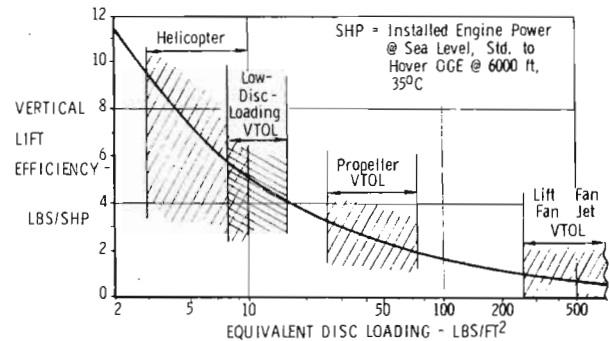

FIGURE 1. VARIATION OF VERTICAL LIFT EFFICIENCY WITH DISC LOADING

It is pointed out that this parameter is a basic measure of aircraft cost-effectiveness since the installed engine power and associated subsystems have a major influence on aircraft initial and operating costs. (It is incorrect to consider this parameter as merely a determinant of hovering fuel rate.) Note that modern pure helicopters with disc loadings of 3 to 10 lbs/sq ft have corresponding main-rotor lift efficiencies of 9 to 5 lbs/shp under the severe hovering altitude/temperature condition specified. Other types of low-disc-loading VTOL aircraft such as compound helicopters and tilt-rotor configurations typically have disc loadings of 8 to 16 lbs/sq ft with corresponding lift efficiencies of 6 to 4 lbs/shp, thus overlapping the pure helicopter characteristic. In contrast, the higher-disc-loading, propeller-lifted VTOL aircraft types, with characteristic disc loadings of 25 to 75 lbs/sq ft exhibit lift efficiencies only half as great, or 3 to 2 lbs/shp, and the high-disc-loading, fanjet-lifted and direct-jet-lifted types, with equivalent disc loadings of 250 lbs/sq ft and higher have lift efficiencies of only 1 lb/shp and below.

"Balanced-Power" Subsonic Performance

A fundamental characteristic of low-disc-loading VTOL aircraft beyond the helicopter as defined above is that they have sufficient installed engine power to permit attainment of relatively high subsonic cruise speeds, provided they are of

reasonably clean aerodynamic design. It can be shown that cruise speed

$$V_{cr} = 326 \frac{\eta L/D}{W/shp} \text{ (knots)}$$

where η is propulsive efficiency, L/D is airframe lift/drag ratio and W/shp is gross weight power loading in pounds/horsepower, all for the ambient conditions at any cruise point. Typical values for a clean proprotor VTOL aircraft of 12 lbs/sq ft design disc loading and 75 lbs/sq ft wing loading are shown in Table 1 for cruise flight at 80% of maximum power at altitudes of sea level and 20,000 feet.

Cruise Altitude ft	η	L/D	W/shp lb/hp	V_{cr} knots
Sea Level	.72	9.5	6.2	360
20,000	.86	14.3	10.0	400

TABLE 1. CRUISE PERFORMANCE OF TYPICAL LOW-DISC-LOADING PROPROTOR VTOL AIRCRAFT

This aircraft has sufficient installed power for hovering out of ground effect at 6000 feet, 35°C. Note that the resulting cruise speeds of 360 and 400 knots approach the maximum that is practicable for propeller-driven aircraft due to compressibility limitations. This indicates that there is little cruise performance gain that can be achieved by using the considerably higher installed power that is required for a medium-disc-loading VTOL aircraft such as the tilt-wing type.

To attain these speeds with low-disc-loading machines requires careful attention to drag reduction in order to achieve good lift/drag ratios at the higher cruise speeds as indicated in Table 1. Also, the propulsive efficiencies shown, while relatively low compared to values attainable with optimum propellers, still require special design effort. These factors will be discussed later.

The indicated speed potential approaching 400 knots means a doubling of the best speeds attainable with pure or winged helicopters of roughly the same power loading. This represents a very large percentage improvement aeronautically speaking, about the same as offered by the Concorde supersonic transport in comparison to the best current subsonic jet transports. It should therefore be expected to entail a considerable engineering effort and perhaps some cost and useful load penalties in comparison to the helicopter.

Environmental Effects

Another factor which tends to favor use of low disc loadings for VTOL aircraft is the environmental problem of the effects in the vicinity of such a hovering aircraft of its downwash and resulting induced wind on ground particle entrainment and surface erosion. Full-scale tests by NASA⁽¹⁻³⁾ have indicated that loose gravel and small pieces of crushed rock are lifted and circulated by the downwash from lifting propellers in the disc loading range from 13 to 19 lbs/sq ft, and small clods of bare sandy soil are lifted at 19 lbs/sq ft. Erosion of wet sand occurs at about 40 lbs/sq ft.

Reference 4 shows that the dynamic pressure exerted on ground objects located at moderate distances from a hovering VTOL aircraft is primarily a function of aircraft weight. By scaling the non-dimensionalized data from one propeller test, Reference 4 concludes that the sliding or overturning tendency of a given ground object will actually be somewhat greater for low-disc-loading machines, based on results such as the curves marked * in Figure 2, which are reproduced from Figure 8 of Reference 4. There is some indication that this conclusion is erroneous due to scale effects, as indicated by the curve marked +, which is replotted from Figure 5 of Reference 4.

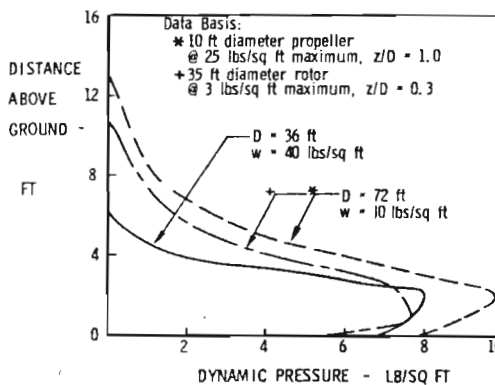

FIGURE 2. PREDICTED DYNAMIC PRESSURE VARIATION WITH HEIGHT AT 72 FT FROM CENTERLINE OF ROTORS PRODUCING 40,000 LBS THRUST AT 10 AND 40 LBS/SQ FT DISC LOADINGS

This is based on data obtained with a low-disc-loading helicopter rotor, and therefore bears a more appropriate parametric relationship to the higher disc loading curve. It tends to support the conclusion that the sliding and overturning effects on ground objects are essentially independent of disc loading for objects located

at some distance from the aircraft. Of course, the situation immediately below the aircraft and within distances from the center of thrust of the order of one fuselage length is quite different, since the dynamic pressures are considerably higher and tend to equal the hovering disc loading, as shown by Figure 7 of Reference 4. This leads to the general conclusion that the downwash disturbances close to a hovering VTOL aircraft are primarily a function of disc loading, while the pressure forces on ground objects subject to the induced wind at points further away from the aircraft are primarily a function of gross weight.

Noise

A second environmental characteristic of VTOL aircraft which is aided somewhat by use of low disc loading is hovering noise. Figure 3 summarizes estimated perceived noise levels at 400 ft from various 80,000-lb hovering VTOL aircraft as a function of disc loading. Several familiar environments are indicated at the left of the figure for reference purposes.

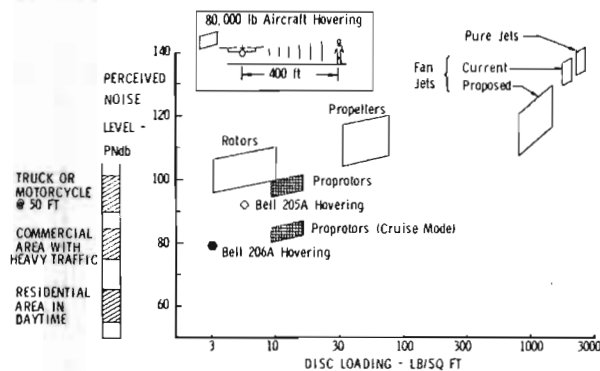

FIGURE 3. VTOL AIRCRAFT SUBJECTIVE NOISE CHARACTERISTICS

Note that a large hovering helicopter is predicted to be slightly noisier at 400 ft than a truck or motorcycle passing at 50 ft, and propeller- and jet-lifted VTOL types are considerably noisier. The low-disc-loading proprotor VTOL type in the takeoff mode will be slightly quieter than the helicopter, and in cruise mode (which might occur at low altitudes over urban areas) will be much quieter due to its large reduction in blade rotational tip speed.

Variable Geometry for VTOL Configurations

Recent aeronautical history has been characterized by a proliferation of variable-geometry applications to circumvent the fundamental aerodynamic constraints of fixed-geometry airplanes. These began

with the variable-pitch propeller, the wing flap and retractable landing gear, and now include variable-sweep and variable-incidence wings, the droopable nose, the all-movable horizontal tail and the variable engine inlet. In all cases, the impetus that leads to these cost- and weight-increasing variable-geometry devices is the pressure for increased speed. A similar trend exists for VTOL aircraft, primarily affecting those designed for higher speeds but also beginning to influence helicopter design. Again speed is the primary objective. The principal physical consideration in VTOL cases is the need to generate a very large vertical force for hovering flight and a lesser but still appreciable horizontal force for high-speed flight.

Helicopter Limitations at High Speeds

For the helicopter, the resulting design problem is illustrated in Figure 4.

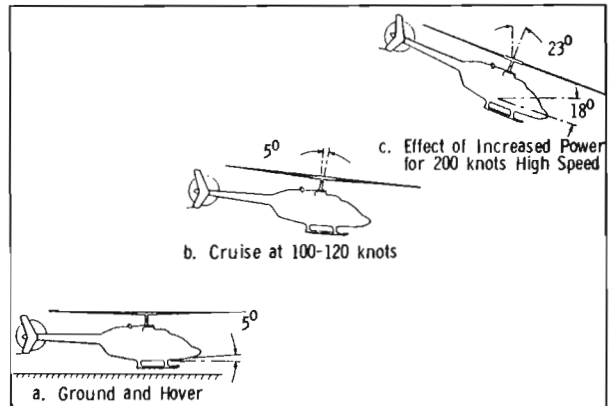

FIGURE 4. ROTOR/FUSELAGE GEOMETRIC RELATIONSHIP FOR TYPICAL HELICOPTER

Typical current pure helicopters require about 5° of forward tilt of the rotor disc plane for steady flight at 100 knots. Most designs incorporate a built-in forward inclination of the rotor shaft axis of about this angle so that the fuselage attitude will be level in cruise as shown at Figure 4b for passenger comfort and minimum drag. The resulting nose-high ground and hover attitude indicated in Figure 4a is not found objectionable. However, if this same fixed-geometry helicopter is pushed to 200 knots in level flight by adding power, a rotor tilt of about 23° is required. With 5° built-in shaft inclination a nose-down fuselage attitude of 18° as in Figure 4c still results which is unacceptable to passengers and crew, causes increased parasite drag, and usually creates an undesirable negative fuselage lift. Fuselage drag reduction can relieve this effect to some

extent, but it remains a real limitation on helicopter speeds of 200 knots and more. The true situation is even more unfavorable than presented in this elementary analysis, since the well-known problems of retreating-blade stall and advancing-blade compressibility drag rise are present. These and other aerodynamic limitations of the lifting rotor at high forward speeds make it increasingly inefficient as a producer of forward thrust, as was pointed out by the author 25 years ago in Reference 5. Addition of a fixed wing to unload the rotor at high speeds may help somewhat, although in some cases it may actually aggravate the situation.

VTOL Aircraft Configuration Development

In order to achieve higher speeds efficiently and comfortably, there is a strong tendency to apply variable geometry to low-disc-loading VTOL aircraft. This is illustrated in Figure 5.

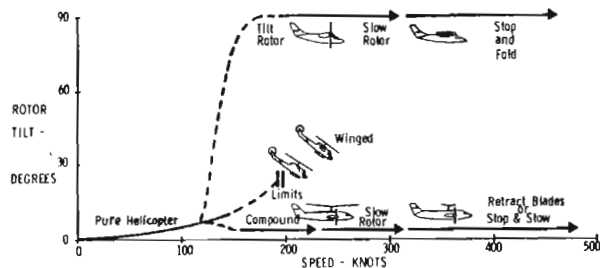

FIGURE 5. VARIABLE GEOMETRY APPLIED TO LOW-DISC-LOADING VTOL TYPES FOR INCREASED SPEED POTENTIAL

The pure helicopter reaches the limits noted above at speeds below 200 knots. A fixed, flapped or variable-incidence wing may be added which can extend the speed range slightly as discussed below. However, for significant advances in speed more drastic geometry changes are required, and the two design branches shown in Figure 5 have developed. The lower one which maintains the lifting rotor essentially horizontal and provides a wing and auxiliary propulsion by propellers or jets leads progressively to the compound helicopter, the slowed-rotor compound helicopter, and the retractable-blade or stowed-rotor VTOL type. The upper branch of Figure 5 also provides a wing but tilts the lifting rotors forward to become propellers, leading progressively to the tilt-rotor VTOL, the same with slowed propellers, and the folding proprotor type with auxiliary propulsion for forward thrust after the proprotors are stopped and their blades

folded aft for minimum drag. In all cases the lifting rotors used in hover are partially or totally unloaded and modified in one or more significant characteristics.

All of the low-disc-loading VTOL types illustrated in Figure 5 are undergoing some degree of research and development at Bell Helicopter Company. In this paper, some of their design problems and solutions will be discussed.

WINGED HELICOPTERS

When pure helicopter designs encounter aerodynamic rotor limits, a frequent solution is the addition of a fixed wing to carry a portion of the lift load at high speed. This decreases the required rotor thrust load and thereby reduces stalling and critical-speed effects. However, it also requires increased forward tilt of the thrust vector in order to generate the force along the flight path needed to sustain any desired flight condition, and this may worsen the geometry problem indicated in Figure 4.

Bell Helicopter Company has flight tested a considerable number of winged helicopter configurations over the past 10 years as part of its investigation of wing/rotor interactions. This work is reported in detail in Reference 6, and several of the helicopters are shown in Figure 6. The only one of these built in quantity production is the Model 209 "HueyCobra" weapons helicopter. In this case, the small wings serve the multiple functions of improving high-speed maneuverability, increasing roll damping and providing a structural pylon for mounting external stores such as rocket pods, fixed guns and auxiliary fuel tanks.

Aerodynamics of Winged Helicopters

Since the span of the fixed wing is usually less than the diameter of the main rotor and since it is usually located not far below the rotor, elementary wing theory shows that the induced drag of the combination will be greater than that of the rotor alone, as indicated by Figure 7. Further, the wing adds an increment of parasite drag, although this is somewhat offset by its generally better L/D than that of the rotor. As a result, unless the wing is added to relieve a badly overloaded main rotor, or unless the rotor is operated at reduced rotational speed, the overall aerodynamic efficiency will be lower in unaccelerated high-speed flight with wing than without. On the other hand, the wing will almost certainly improve other characteristics at high speed such as maneuverability, vibration level and fatigue loads on rotor and control components.



Winged High Performance Helicopter



Model 209 HueyCobra



Model 207 Sioux Scout

FIGURE 6. TYPICAL BELL WINGED HELICOPTERS

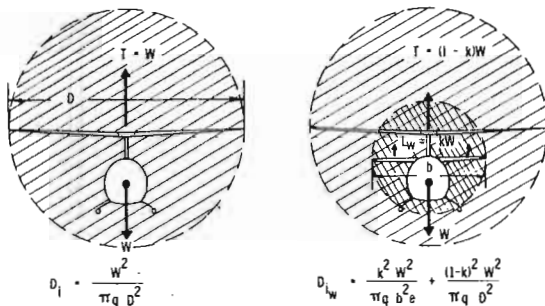

$$D_i = \frac{W^2}{\pi q D^2}$$

$$D_{iw} = \frac{k^2 W^2}{\pi q b^2 e} + \frac{(1-k)^2 W^2}{\pi q D^2}$$

$$\frac{D_{iw}}{D_i} = 1 + k^2 \left[\frac{D^2}{b^2 e} - 1 \right]$$

q is dynamic pressure
e is wing span-efficiency factor

FIGURE 7. COMPARISON OF INDUCED DRAG OF HELICOPTER WITHOUT AND WITH FIXED AUXILIARY WING

Autorotation with Wings

In autorotative flight, since an added wing carries a fraction k of the total lift load, the rotor will tend to autorotate at $\sqrt{1-k}$ of its wingless autorotational speed for a given blade pitch setting. Since pilots prefer to have full rotational energy available for autorotative landings, they usually request that the autorotative pitch setting be lowered to regain full rpm in a normal autorotative glide in a winged helicopter. The result is that a significant advantage of the winged machine is lost, since autorotation at reduced rpm can "stretch" the glide by up to 50%, as indicated by Bell tests. Flapping angle will be somewhat larger, but should not be troublesome, and full rpm can usually be regained easily by a cyclic flare to reduce airspeed prior to touchdown. Therefore, even if a lower autorotative pitch setting

is used for winged helicopters, it may prove advantageous to train pilots to glide at higher than minimum pitch when a flatter angle of descent is desired.

Disadvantages of Wings

In hovering flight, a fixed wing penalizes the helicopter both by its weight and by the aerodynamic download on it caused by the main rotor. An approximate expression for this load (and therefore the additional thrust that must be produced by the rotor) is:

$$\Delta T = 0.7 \frac{A_w}{\pi R^2}$$

Other disadvantages of wings, which usually are mounted close to the main transmission and center of gravity, include their interference with maintenance access to various major components, their increased hangar space requirements (at least for two-bladed helicopters), and the occasional need to remove them when the helicopter is to be transported by truck or by air.

Winged Helicopter Design Study

Almost without exception, wings have been added to pure helicopters as an afterthought, or to extend existing rotor system capabilities to higher speeds. There has been a continuing debate on the advantages of designing a new helicopter with an integral fixed wing. Bell has conducted a recent study of this question, based on the parameters listed in Table 2. Using these values and a typical clean airframe design resulted in designs for which rotor blade area was traded off against wing area s_q as to maintain the desired maneuver capability at a constant design gross weight and mission endurance. Installed engine power was determined by the hover requirement, including any penalty

Disc Loading = 6.0 lbs/sq ft
Hover Ceiling, OGE, 35°C = 4000 ft
Advanced Turbohaft Engines
Advanced Blade Aerodynamics
Maneuver Capability at Maximum
Cruise Speed = 2.0g
Tip Speed = 725 ft/sec

TABLE 2. DESIGN PARAMETERS FOR WINGED HELICOPTER STUDY

due to the wings. From this procedure, cruise speed and mission payload emerge as dependent variables, with the results shown in Figure 8. Within the precision of the analysis, there is zero benefit or penalty from the incorporation of a fixed wing in the initial design. Differences in required fuel load were also negligible.

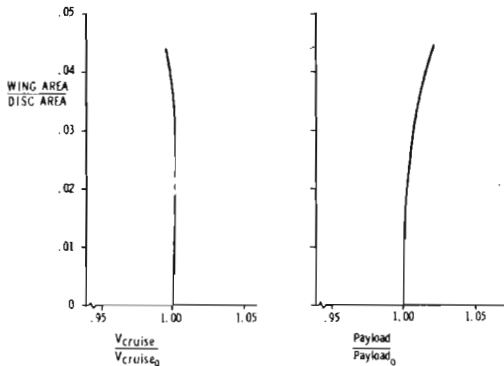

FIGURE 8. RESULTS OF STUDY TO DETERMINE VALUE OF FIXED WING AS PART OF INITIAL HELICOPTER DESIGN

It may be concluded that fixed wings should not be added to new pure helicopter designs in order to obtain better performance. They may, however, be justified for reasons such as:

- Improvement of vibration and/or dynamic structural load characteristics, particularly in maneuvering flight
- Provision of structural attachment points for landing gear, weapons or external stores
- Improvement of roll control and/or damping
- Provision of shade in desert operations

COMPOUND HELICOPTERS

The U. S. Army/Bell HPH Program

Over the past 8 years, an extensive program of flight research supported by

related analytical development and wind tunnel testing has been conducted around the U. S. Army/Bell High-Performance Helicopter (HPH). The basic vehicle is a YUH-1B modified with fairings to reduce airframe parasite drag. As described in Reference 7, it has been flown in a large variety of configurations including the pure, variable-pylon-tilt, auxiliary-jet-propelled, winged, and full-jet-compound helicopter in combination with ten different main rotors ranging from the basic two-bladed seesaw type to several four-bladed rigid types. The latest series of research flight tests was conducted in a new full-compound configuration having a 78-sq ft shoulder wing with 3300-lb-thrust JT12A-3 jet engines mounted at each wing tip, 8.7 ft from the aircraft centerline. The aircraft is shown in flight in Figure 9 with the low-twist two-bladed UH-1B rotor as it was flown in 1969 and in Figure 10 with the four-bladed flexbeam ("rigid") rotor as it was flown in 1970.



FIGURE 9. HPH COMPOUND HELICOPTER IN FLIGHT WITH TWO-BLADED ROTOR



FIGURE 10. HPH COMPOUND HELICOPTER IN FLIGHT WITH FOUR-BLADED ROTOR

A standard UH-1B tail rotor was used. Shaft power was supplied by a 1400-shp T53-L-13 engine. Principal parameters for these two configurations are given in Table 3.

	Two-Bladed Semi-Rigid Rotor	Four-Bladed Flexbeam Rotor
Design Gross Wt	8500 lbs	8500 lbs
Typical Takeoff Wt	9500 lbs	10500 lbs
Wing Span (incl engine cowl)	19.6 ft	19.6 ft
Wing Chord	4.0 ft	4.0 ft
Horizontal Stabilizer Vol	2.42	3.37
Rotor Diameter	44.0 ft	44.0 ft
Blade Chord	1.75 ft	1.75 ft
Blade Twist	-1.83 deg	-6.00 deg
Rotor Solidity	.0507	.1014

TABLE 3. SUMMARY OF DESIGN AND TEST PARAMETERS OF THE U. S. ARMY/BELL HPH FLOWN IN 1969-70

Flight Test Results

The principal achievements of the flight program are given in Table 4. (9) The tests were designed to investigate rotor behavior and control characteristics under extreme conditions. The maximum level-flight speed of 275 knots attained with the two-bladed rotor is believed to be the highest ever reached by any type of helicopter. This condition was relatively smooth, primarily due to the approximate 90% unloading of the rotor, and this should dispel the common misconception that two-bladed rotors have inherent speed limitations. Maneuverability was limited by dynamic structural loads at the higher speeds, but the substantial load factor of 2.0g (referred to design gross weight) was attained at 225 knots.

The primary purpose of the tests with the four-bladed rotor was to investigate higher maneuvering load factors, and the value of 2.8g (again referred to design gross weight) attained at over 200 knots is considered commendable for a rotorcraft. The low vibrations characteristic of this configuration in both level flight and maneuvers were noteworthy. While the highest recorded level-flight speed of 221 knots was somewhat below the maximum attainable, the power and drag penalties of the additional blade area and the less favorable blade twist were clearly responsible for a major portion of the decrease from the 275-knot speed attained with the two-bladed rotor installed.

HPH Control System and Flight Characteristics

One of the basic problems of the compound helicopter is its control system complexity - it has about double the number of control functions of the pure helicopter - and its associated somewhat indeterminate control characteristics - specific combinations of speed and rate of climb can be established with different control settings and aircraft attitude combinations. Further, customary control applications can cause excessive structural loads, rotor overspeeds or unsafe attitudes at high speed. This is undesirable from the standpoints of initial training requirements, maintenance of proficiency and flight safety. It also creates the need for a second pilot to monitor the keeping of multiple functions within safe limits. An objective of the Bell HPH program was to avoid this situation by configuring the control system so that it could be adapted (manually in the test vehicle, but potentially automatically) for relatively simple and unambiguous operation by a single pilot in all flight regimes. Accordingly, a control conversion concept was developed for the primary source of difficulty, the longitudinal system. The conversion mechanism

Type Rotor	Adv. Tip Mach No.	Maneuver Load Factor	Adv. Ratio	Max. Speed Level Ft.
Two-Bladed Seesaw UH-1B Hub -2° Twist, Thin-Tip Blades	1.01	2.0 g @ 225 kt	.73	275 kt
Four-Bladed Rigid Flexbeam Hub -6° Twist, Thin-Tip Blades	0.98	2.8 g @ 200 kt	.55	220 kt

TABLE 4. PRINCIPAL RESULTS OF THE U. S. ARMY/BELL HIGH-PERFORMANCE COMPOUND HELICOPTER FLIGHT TEST PROGRAM IN 1969-70

progressively decreased cyclic feathering amplitude (swashplate angle) as it progressively increased stabilator travel. The schedule used is shown in Figure 11.

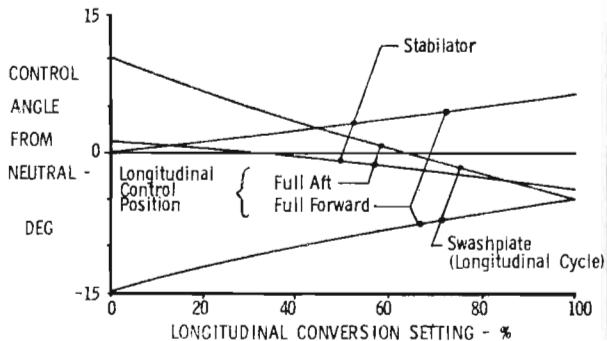

FIGURE 11. LONGITUDINAL CONVERSION SCHEDULE FOR TWO-BLADED HPH

The pilot technique in applying this device was to establish a preferred sequence of application by means of step-by-step exploration at increasing airspeeds, and then follow this "normal operating procedure" on subsequent data flights. The pattern developed was to fly from hover to 120 knots at 0%, shift to 50% for the range from 130 to 160 knots, and shift to 100% at 170 knots and above. This provides a good compromise between performance and structural/dynamic loads, and combined with the "normal" collective pitch setting of about 16% used above 220 knots, results in a rotor lift of about 10% of gross weight at 275 knots. (Rotor lift was reduced to zero in mild maneuvers at maximum speed.)

Power Failure Characteristics

The problem of entering autorotation after power failure at high speed has generated much attention in compound helicopter design, since geometric parameters will usually be such as to increase the already high fraction of aircraft weight being carried by the wing when aircraft angle of attack increases following power reduction. In the case of the HPH, two special provisions were made for test evaluation:

- Wing spoilers located at 10% chord, coupled to the stabilator for trim compensation, and controlled by a switch located on the pilot's collective control head.
- Symmetric operation of the ailerons as flaps with deflection from neutral coupled to collective pitch such that 20° of up flap deflection is introduced as collective is reduced from about 20% to 0% setting. Automatic stabilator trim is provided here also.

Pilot reaction was unfavorable to both of these devices, basically because they required an additional special control action in a dynamic emergency flight condition. The spoilers were found to produce excessive negative pitching moment for which the stabilator coupling did not adequately compensate. Furthermore, it was found that the problem (excessive loss of rotor speed in high-speed autorotation) had been overemphasized since relatively simple pilot techniques handle it satisfactorily. These consist of adding rotor thrust by positive-normal-acceleration maneuvers such as a simple flare or a flare followed by rolling into a banked turn for entry airspeeds above 180 knots. In both cases, the normal acceleration is held until airspeed drops below 150 knots, at which time longitudinal control conversion is reset to zero and the aircraft continues to decelerate and descend at 1g normal load factor. Figure 12 shows the time history of a simulated rotor engine failure at 215 knots.

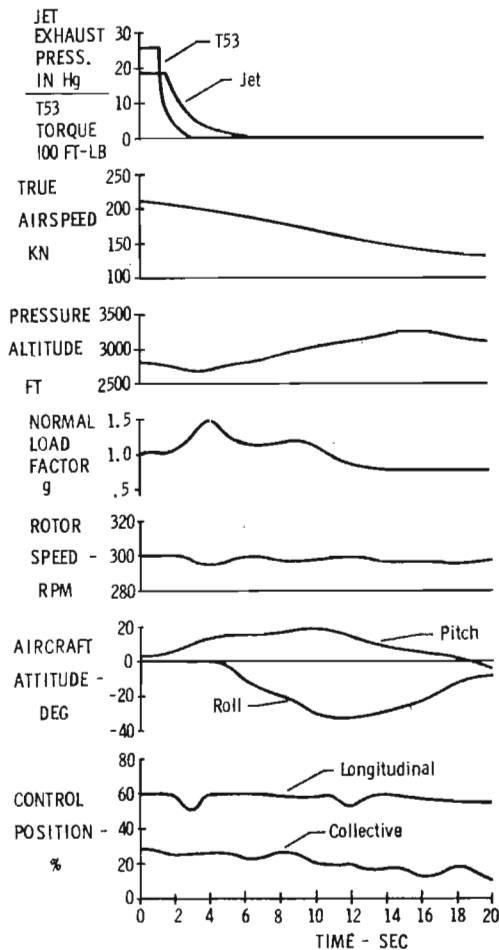

FIGURE 12. TIME HISTORY OF SIMULATED ROTOR ENGINE FAILURE IN HPH AT 215 KN

For test purposes, a device which automatically retarded the jet engine throttles to flight idle whenever the rotor turbine control setting reached the idle stop was installed. It made feasible single-pilot entries into autorotation, the only maneuver that originally required a co-pilot. This device might have merit for an operational compound helicopter that is required to enter rapid descents from high-speed flight.

An interesting sidelight to both maximum load factor and simulated power failure maneuvers conducted at high airspeeds and fixed collective pitch settings was that prevention of main rotor overspeeding required little attention from the pilot, without help from any type of governor. (In helicopter maneuvers at lower airspeeds, this function would normally demand considerable pilot manipulation of the collective pitch control.) This result is attributed to the fact that the entry conditions for most of these maneuvers placed the advancing blade tip Mach Number above 0.9, and therefore any tendency to increase rotational speed produced a sharp compressibility drag rise and consequent decelerating profile torque which approximately balanced any accelerating torque from blade lift forces generated in the maneuver. Thus an aerodynamic self-governing effect appears to exist in high-speed maneuvers.

Compound Helicopter Performance Potential

Performance of compound helicopters is improved at high airspeeds by reducing the rotational speed of the unloaded main rotor so as to reduce blade profile drag and torque.⁽⁸⁾ This effect would be expected to be more pronounced with the four-bladed rotor on the HPH, and Figure 13 shows an excellent set of conformatory data taken during a rotor speed sweep at 195 knots true airspeed, holding jet thrust constant. The rotor speed decrease of 40 rpm (12%) resulted in a 500 shp drop in required T53 engine power, with the rate of change decreasing as advancing tip Mach Number dropped toward 0.90. A corresponding improvement in total aircraft L/D of 25% was obtained as shown in the lower portion of the figure. However, even allowing for test aircraft configuration penalties, the improved value must still be considered unsatisfactory from the standpoint of achieving an efficient high-cruise-speed transport rotorcraft. Independent analyses made at Bell confirm this problem and suggest that the potential performance gains with compound helicopters may not be sufficient to justify their added cost and complexity. On the other hand, if moderate speed gains in the over-200-knot area are required, the compound helicopter with some rotor slowing at high speed may well be the optimum solution.

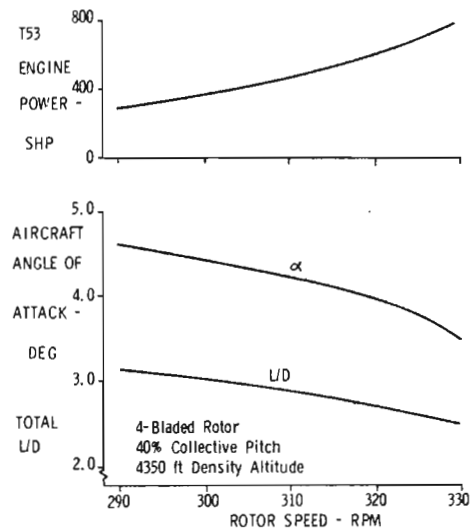

FIGURE 13. EFFECT ON ROTOR SHAFT POWER AND TOTAL AIRCRAFT LIFT/DRAG RATIO OF VARYING ROTOR SPEED AT 195 KNOTS

Figure 14 summarizes the results of a Bell design study⁽¹⁰⁾ which shows the effect of design maximum speed on the weight of propulsion system plus fuel for pure helicopter designs and two types of compound helicopters.

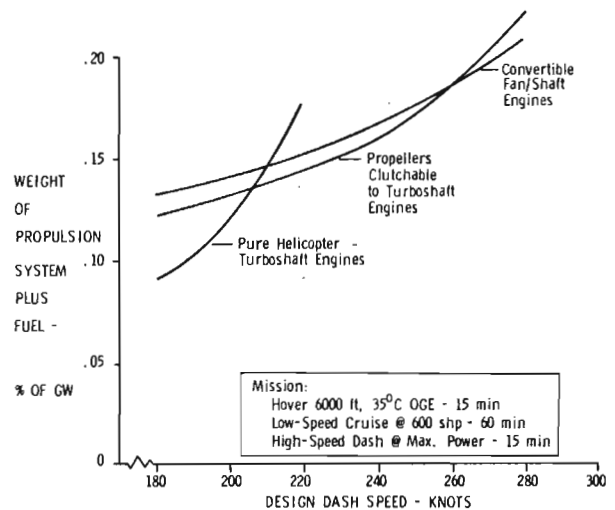

FIGURE 14. EFFECT OF DESIGN-SPEED ON PROPULSION PLUS FUEL WEIGHT FOR PURE AND COMPOUND HELICOPTERS

Of the assumed 1.5-hour mission, only 15 minutes is assumed at dash speed. For dash speeds to about 210 knots, the pure helicopter shows a weight advantage (and would also have a simplicity advantage). At higher design dash speeds, the compounds are superior. The convertible fan/shaft engine propulsion system shows up as somewhat lighter than the clutchable propeller drive system for speeds above about 260 knots.

VARIABLE-DIAMETER ROTORS

A further extension of the variable-geometry approach to low-disc-loading VTOL aircraft is the retractable-blade or variable-diameter rotor (VDR) concept. Contracting the blades to a smaller diameter while continuing their rotation at either full or reduced rotational speed is an effective way to reduce the profile drag and power of a rotor at high forward speeds, and has been suggested by several researchers.⁽¹¹⁻¹³⁾ Figure 15 shows a ground test rig of this principle, using a modified Model 47 drive system and full-scale telescoping blades that Bell has in current operation. This mechanism has successfully completed over 800 retraction/extension cycles including over 300 on the current set of cables. Note that the diameter can be reduced to 60% of maximum. This device uses no other source of retraction power than the basic rotor drive from the engine. In this case, multiple tension cables are used to draw in the outer 40% of the blade to rest within the inner blade shell of slightly larger chord and thickness; however, a screwjack mechanism as proposed by Sikorsky⁽¹²⁾ could also be used. Figure 16 shows a sketch of a possible compound helicopter using this type rotor. The blades are indicated in their retracted position. Multiple telescoping segments to reduce diameter to 25% or less could also be developed, at the cost of somewhat increased complexity.

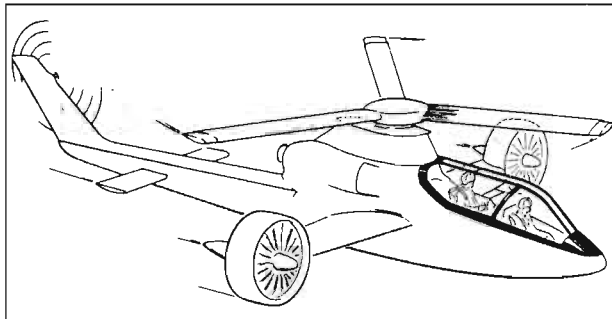

FIGURE 16. HIGH-SPEED COMPOUND HELICOPTER WITH VARIABLE-DIAMETER RIGID ROTOR - BLADES CONTRACTED

Using standard expression such as from Reference 5, it can easily be shown that the total profile power absorbed by a rotor with low-twist blades operating near zero lift is approximately

$$P_o \approx \rho b c \delta_o \omega^3 R^4 \left(\frac{1}{8} + \frac{3}{8} \mu^2 + \frac{2}{3\pi} \mu^3 + \frac{3}{64} \mu^4 \right)$$

Using this expression for a typical case at 275 knots, the profile power loss due to the blades of a rotor contracted to 25% of full diameter is only about 12% of its magnitude at full diameter and equal rotational speed. With reduced rotational speed the saving would be somewhat greater. Thus, contracting the blades to about 25% of their hovering diameter and perhaps slowing them somewhat will accomplish the major part of the saving that would be realized by stopping the rotor and retracting the blades completely. However, for this to be of real benefit, hub and exposed rotor shaft drag must be kept to a minimum. A further advantage of this approach is that, as rotor diameter is reduced for high-speed flight, the dynamic problems usually associated with rotors in this condition may be expected to decrease progressively. At 25% of full diameter, the remaining exposed portion of



FIGURE 15. VARIABLE-DIAMETER ROTOR TEST SHOWING CONTRACTION TO 60% DIAMETER

the blade could be expected to act only as a slowly rotating stiff strut with little of the dynamic characteristics (and problems) of a rotor blade. It may thus be preferable as a solution to the slowed-rotor compound helicopter which is known to have potentially severe dynamic problems.⁽⁸⁾

The results of a recent Bell study to compare these two approaches are given in Figure 17 for a hypothetical test vehicle. It may be noted that the gain in equivalent L/D in comparison to the baseline is nearly equal for slowing the rotor to 60% rpm or reducing its diameter to 60% at constant rpm. The difference is due to the hub drag of the VDR offset by the greater profile power reduction of the VDR approach. The VDR machine with 25% diameter is, as expected, the most efficient.

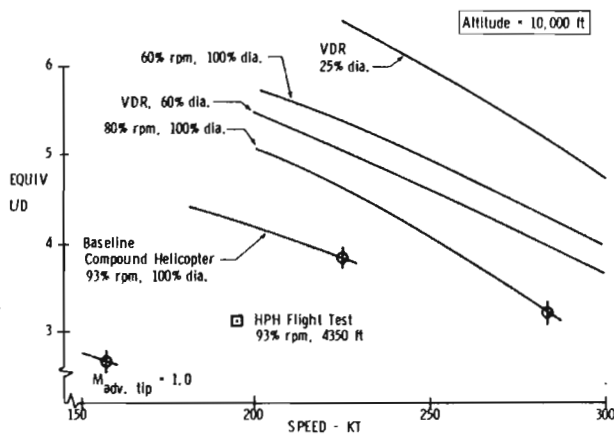

FIGURE 17. COMPARISON OF THE CRUISE EFFICIENCY OF CLEAN COMPOUND HELICOPTERS WITH SLOWED AND VARIABLE-DIAMETER ROTORS

TILTING PROPROTOR VTOL AIRCRAFT

Returning to Figure 5 and following the upper branch of the curve, the concept of achieving high speed with a VTOL

aircraft by tilting the vertical-lift-generating device through 90° to provide forward propulsion is both obvious and old. It has been used experimentally over the full range of disc loadings shown in Figure 1 from the direct-lift jet down to the low-disc-loading rotor. An example of the latter is the Bell XV-3 shown in Figure 18 in its hovering, converting and cruising configurations. This aircraft was flight-tested in 1958-60⁽¹³⁻¹⁵⁾ and was also tested in the NASA Full-Scale Wind Tunnel.^(16,17) It had a disc loading of 5.8 lbs/sq ft and a power loading of 10.8 lbs/shp.

The XV-3 proved that the tilting/prop-rotor concept was feasible and demonstrated the ease of the conversion process.^(14,15) It also showed the potential for attaining acceptable prop-rotor propulsive efficiencies by operating at rotational speeds well below those used for helicopter flight.⁽¹⁶⁾

By virtue of its high-aspect-ratio wing and clean high-speed configuration, this type has been shown^(17,23) to have the potential for efficient cruise (overall L/D including losses from 5 to 10 depending on speed and altitude). As a result it begins to be competitive with conventional airplane utility-transport types, and it is clearly more efficient aerodynamically than an equivalent STOL airplane because of its higher wing loading. Its empty weight is somewhat higher than that of comparable airplane types, which is the cost of VTOL performance. Figure 19 shows a representative 10,000-lb commuter/executive tilting prop-rotor model capable of 300 knots maximum speed.

Prop-rotor Technical Problem Areas

The XV-3 tests together with subsequent analytical and wind-tunnel model investigations have shown four principal technical problem areas of this type:

- Large flapping amplitudes
- Prop-rotor/pylon dynamic stability
- Short-period aircraft dynamic stability
- Oscillatory blade loads in gusts and maneuvers



FIGURE 18. BELL XV-3 IN HOVERING, CONVERTING AND CRUISING FLIGHT



FIGURE 19. COMPUTER/EXECUTIVE PROPROTOR VTOL DESIGN

Bell has conducted an extensive research effort in these areas to gain a thorough understanding of the problems and to develop and test design solutions for them. (18,19)

Flapping Amplitudes

Like helicopter rotor blades, prop rotor blades are hinged or flexibly mounted to their driveshaft so as to greatly reduce blade root bending moments and thus avoid excessive blade structural weight. As a result, the blades execute flapping motions with respect to a plane normal to the shaft axis, so as to minimize cyclic variations in blade section angle of attack around the azimuth due to shaft angle of attack or yaw with respect to the free stream, and so as to generate the aerodynamic moments required to precess the rotor at the pitching or yawing rate of the shaft axis. While the flapping motion itself causes no problem, its amplitude tends to increase as flight speed increases, and it is important to avoid hitting the static flapping stops and to maintain clearance between the blade and the wing leading edge. Accurate computerized methods have been developed to calculate the flapping response of a highly twisted blade at high axial advance ratios. Typical computed flapping derivatives for a 28,000-lb design are shown in Figure 20 to agree closely with recent model test results. Dynamically-scaled semi-span wind tunnel models of the type shown in Figure 21 have been used for this and other types of exploratory and confirmatory testing.

The most common method of reducing flapping is the use of pitch-flap coupling (delta-three). Although not generally

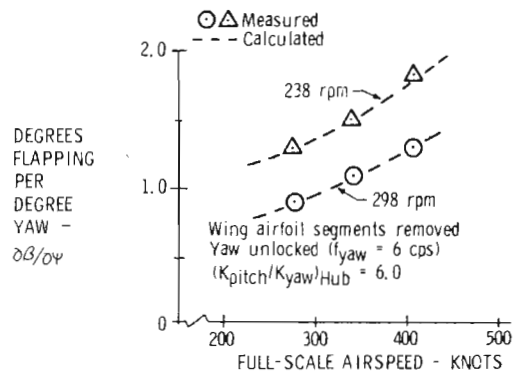

FIGURE 20. CORRELATION OF FLAPPING DERIVATIVE ANALYSIS WITH DYNAMICALLY-SCALED MODEL TEST

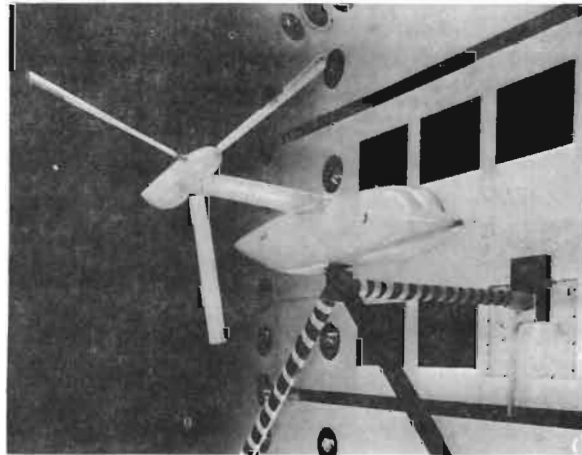

FIGURE 21. DYNAMICALLY-SCALED PROPROTOR/PYLON/WING SEMI-SPAN WIND TUNNEL MODEL

realized, positive coupling (pitch increase with upward or forward flapping) is equally as effective as negative coupling; the former is used on Bell designs since it avoids blade motion instability as discussed in Reference 19. Other approaches to reduce flapping include spring restraint of flapping motion and use of an automatic flapping controller. The latter is a feedback device which minimizes steady-state flapping and somewhat reduces the amplitude of transients.

Prop rotor/Pylon Dynamic Stability

This problem was experienced during full-scale wind tunnel tests of the XV-3, and has been the subject of intensive analysis and experimental investigations at Bell and elsewhere. The basic cause is the same as that of propeller whirl flutter-aerodynamic forces on the blades generated

by precession of the proprotor disc due to pitching or yawing deflections of the shaft axis. In the proprotor case, in-plane shears are the primary forces which destabilize the pylon, and pylon damping has only a small stabilizing effect. The basic solution is to minimize angular motion of the rotor control plane by use of stiff mounting structure or by applying some form of blade pitch feedback. At the same time natural frequency relationships which lead to negative damping are reduced or eliminated. Bell engineers have developed analytical methods which handle this problem with consistent success, when judged by correlation with model and full-scale tests. The latest of these was completed in July 1970, using the flightworthy 25-ft proprotor shown in Figure 22 mounted on a simulated wing structure. Testing was primarily directed at proprotor/pylon stability and demonstrated good stability of all modes through the maximum simulated speed of 408 knots.

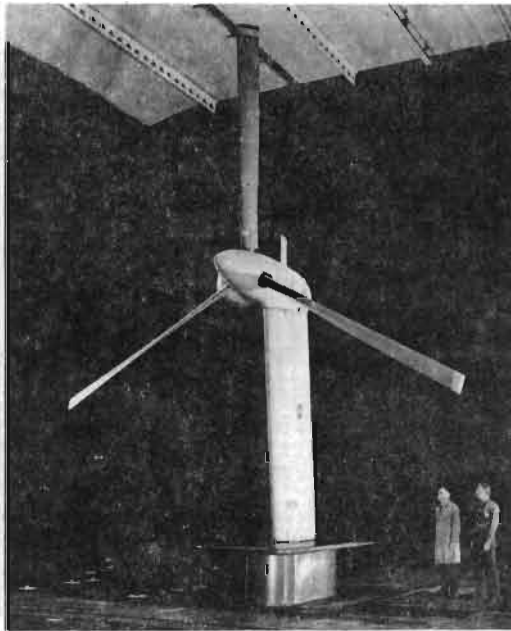

FIGURE 22. FULL-SCALE PROPROTOR MOUNTED IN NASA AMES 40 x 80 FT WIND TUNNEL

Test data for damping of the primary wing beam mode are shown in Figure 23, together with previous 1/5-scale model test results, for comparison with the calculated curve. Note the excellent agreement, with the prediction being on the conservative side.

The data of Figure 23 were all taken in the windmilling condition which the analysis shows to be representative of the complete power range from the proprotor

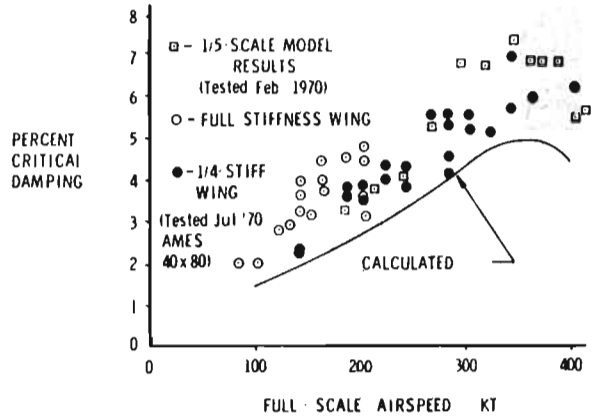

FIGURE 23. CORRELATION OF MODEL AND FULL-SCALE WIND TUNNEL TESTS OF PROPROTOR/PYLON STABILITY WITH ANALYSIS

stability standpoint. Confirmation of this conclusion was obtained in a previous model test run at NASA Langley and reported in Reference 19, from which Figure 24 is taken. Positive values of thrust indicate a net propulsive force. For the tested range which exceeded that for normal flight, damping levels remain essentially constant.

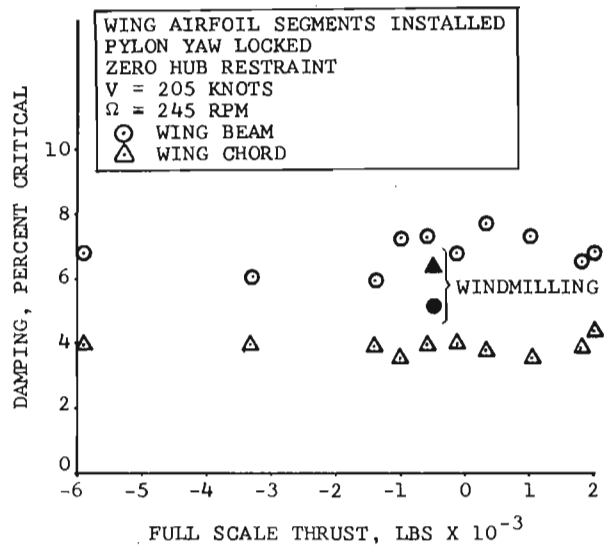

FIGURE 24. EFFECT OF THRUST ON WING BEAM AND CHORD DAMPING IN DYNAMIC MODEL TESTS

The proprotor/pylon instability discussed above occurs with the rotor blade acting essentially as a rigid body and coupling with the wing/pylon elastic modes.

Another form of instability can occur in which blade rigid body flapping couples with in-plane bending. This has been termed blade motion instability and can occur when negative pitch-flap coupling is present. It is eliminated by using positive pitch-flap coupling on stiff in-plane rotors.

Short Period Aircraft Dynamic Stability

The same in-plane aerodynamic shear forces which arise from proprotor precession also tend to destabilize the aircraft short-period pitch, yaw and "Dutch-roll" modes, with the effects increasing with altitude.⁽¹⁶⁾ Analyses and dynamic model tests have shown that the usual airplane solution of increased tail volume is effective in correcting any deficiencies. Blade flapping spring restraint is also helpful here. Electronic stabilization can also be used as a supplemental approach.

Blade Loads in Maneuvers and Gusts

Because of its operation over a large pitch range and at high driving torques, a proprotor blade is subject to more severe structural loads than is a comparable helicopter rotor blade. In high-speed flight maneuvers and gust conditions, in-plane oscillatory blade bending loads can become quite severe and require strong blade roots in the beamwise as well as the chordwise direction. Design studies have shown that these loads can be handled with available structural materials at reasonable weights, and the blades shown in Figure 22 are designed to relatively severe fatigue criteria.

FOLDING PROPROTOR VTOL AIRCRAFT

Like any propeller-driven airplane the tilting proprotor type begins to experience aerodynamic limitations at about 350 knots, and satisfactory propulsive efficiency is difficult to maintain much above this speed. This has suggested a further step in the variable-geometry approach to VTOL, the folding proprotor (FPR) type, which offers aerodynamic efficiency close to that of the jet airplane at high subsonic speeds. Figure 25 illustrates the concept. After conversion to proprotor flight, propulsive thrust is transferred to cruise fans and the windmilling proprotor blades are feathered, stopped and folded aft to nest along the wingtip nacelle.

Proprotor Feathering and Stopping

The feather-stop sequence and its reverse have been studied in several series of wind tunnel tests, most recently with the full-scale rotor shown in Figure 22.

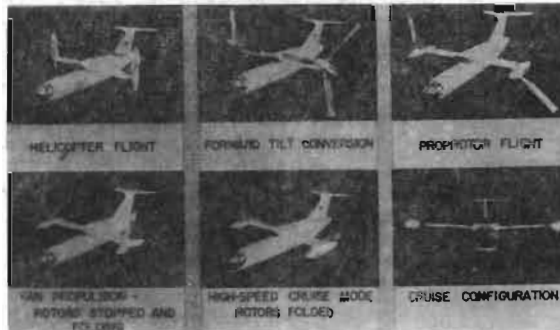

FIGURE 25. FOLDING PROPROTOR AIRCRAFT CONVERSION SEQUENCE

The aerodynamic flow field ahead of the lifting wing causes additional blade loads, but tests show these to be well within normal limits. As the proprotor is slowed to a stop, at some point its rotational speed will equal the wing fundamental bending frequency. Tests have shown that this resonance is fairly well damped and causes no distress when the rate of stopping is reasonably rapid. The blades must be indexed to their correct folding azimuth after stopping, and this process appears to be aided somewhat by the wing flow field. The folding process must be accomplished in flight under adverse conditions, and the effects of gusts have been investigated analytically. Figure 26 shows a computed time history for an initial speed of 175 knots, with a typical FPR subjected to a 25 ft/sec sharp vertical gust when it had slowed to about 15% rpm, using a feathering rate to achieve stopping in about 4 seconds. In this case, the gust caused no control difficulty but did impose a vertical acceleration increment of nearly 0.5g. Reference 22 reports further analyses of FPR stability and control characteristics.

Blade Folding Development

Blade folding represents a fairly straightforward mechanical design problem which has been worked by Bell designers at both model and full scale. Figure 27 shows a folding proprotor model undergoing flutter testing in a wind tunnel. The 45° position appears to be most critical but does not cause trouble with reasonable control stiffness and blade mass balance. Full-scale design studies indicate that hydraulic fold actuators are probably most practical for the rotating system. Figure 28 shows a full-scale mock-up undergoing development testing.

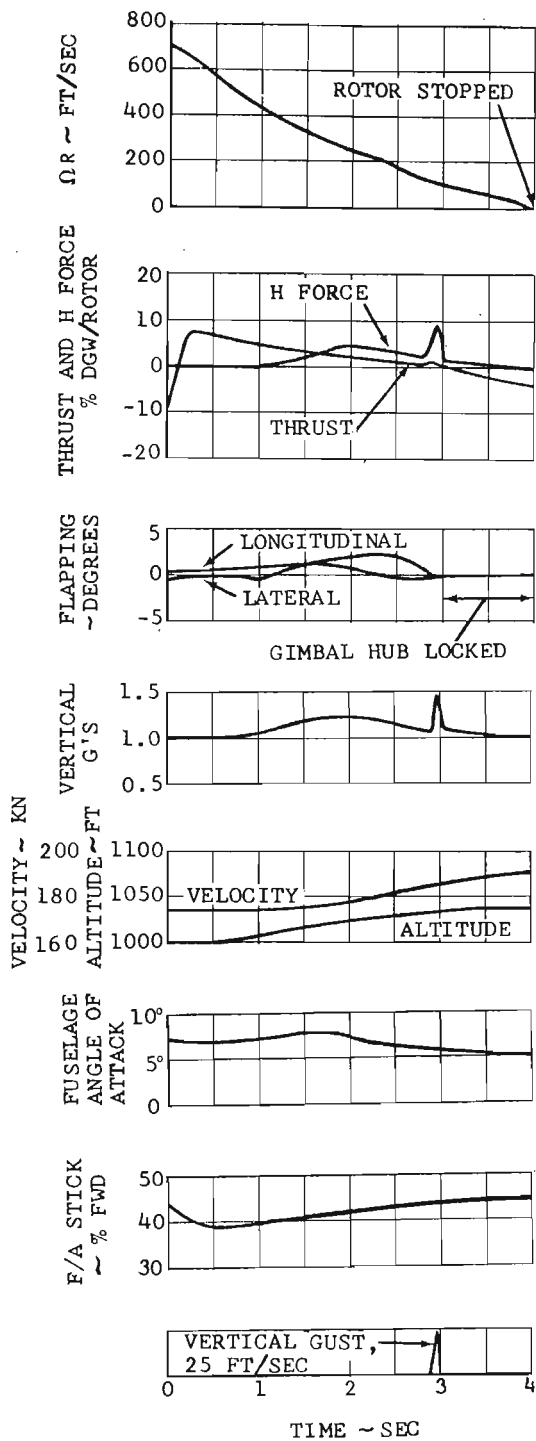

FIGURE 26. CALCULATED AIRCRAFT CHARACTERISTICS DURING ROTOR STOPPING WITH VERTICAL GUST



FIGURE 27. EXPLORATORY WIND TUNNEL TEST OF FLUTTER OF FOLDING PROPROROTOR

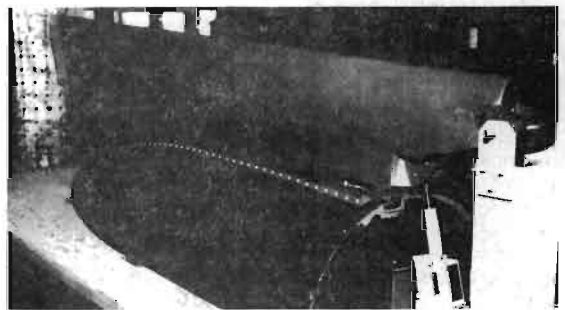

FIGURE 28. FULL-SCALE BLADE FOLD TEST USING MOCK-UP COMPONENTS

FPR Applications

The folding prop rotor VTOL type provides a means of attaining high subsonic cruise speed with a low-disc-loading VTOL aircraft type which does not appear to involve any major development risk. Since the stop-fold process occurs in the vicinity of 150 knots, dynamic problems would appear to be minimal. Reasonable L/D values can be attained at speeds of 400 knots and above. Figure 29 shows a FPR rescue/transport configuration.

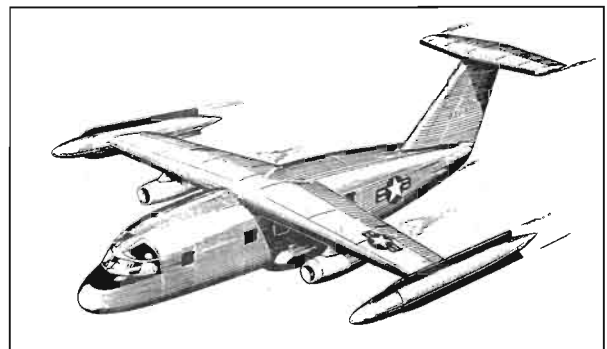

FIGURE 29. FOLDING PROPROROTOR RESCUE/TRANSPORT DESIGN STUDY

CONCLUDING REMARKS

The world-wide acceptance of the helicopter as a highly useful, though specialized, flight vehicle is based largely on its ability to lift an economical payload vertically, and as required, to transport it horizontally at relatively low speeds. Since the primary justification of aircraft has always been speed, it is reasoned that significant speed improvement over the helicopter, provided that its payload-lifting ability is retained, will lead to broadly useful VTOL aircraft.

This paper is based on the premise that the most certain course leading to this goal is to hold on to the proven advantages and technology of the helicopter, and the most fundamental of these is the use of low disc loadings in the hovering flight mode. On this basis, it has been shown that a series of VTOL types is technically feasible, branching out from the helicopter in two main directions as shown in Figure 5, and attaining progressively higher forward speeds by the application of more sophisticated aerodynamics and variable geometry in five principal configurations.

Each of these configurations has its own set of advantages and disadvantages, and only actual construction and flight testing (and perhaps not even this) will provide reliable answers as to the true feasibility of each approach and its relationship to the others. Therefore, it is not possible to draw firm conclusions here or to make specific recommendations.

One comparative aspect that can be evaluated with some confidence is the relative cruise performance of the various types, and this has been attempted in Figure 30, which shows estimated practically attainable ranges of the basic cruise efficiency parameter, L/D. For comparative purposes, the D term includes the equivalent of all power-consuming losses associated with the configuration such as gearing friction, cooling and the aerodynamic losses of propulsive devices. The comparison assumes practical design parameters with only those refinements attainable in the immediate future. A single altitude of 10,000 ft is shown, and this is somewhat unfair to the higher-speed configurations which improve their L/D with altitude.

Figure 30 shows that the high-rpm compound helicopter offers a significant improvement over the helicopter in the 200-250 knot speed range, and that further substantial gains can be achieved to perhaps 275-300 knots by slowing or contracting the main rotor when it is operating unloaded. A further substantial gain is made with the twin tilting-rotor configuration which approaches airplane L/D's and appears feasible for the 250-350 knot range. Folding proprotors will probably take over at about this point and appear to be the preferred configuration for 400 knots and above. These conclusions based purely on performance must, of course, be modified by the fundamental factor of VTOL payload fraction and basic considerations such as stability, control and comfort.

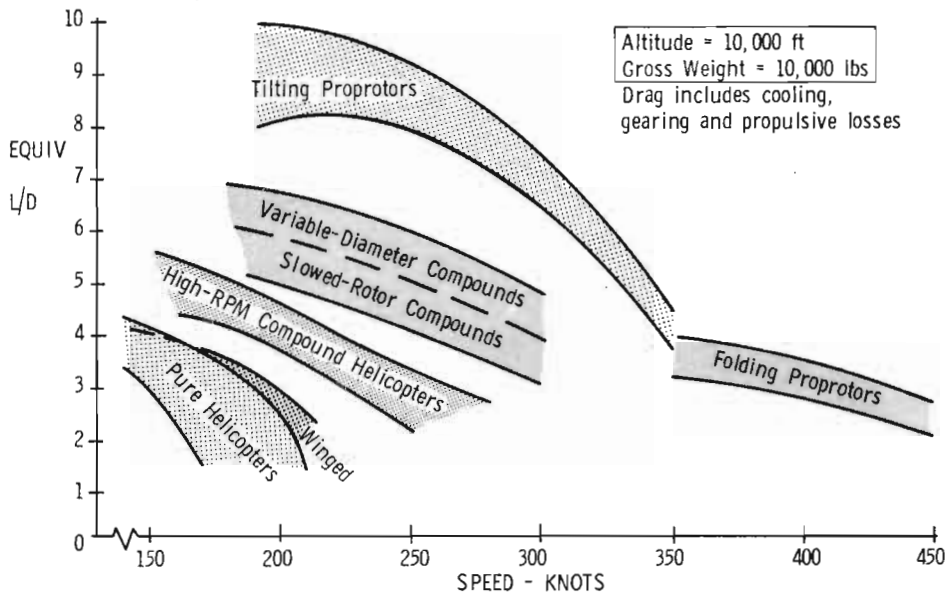

FIGURE 30. COMPARISON OF NEAR-FUTURE ATTAINABLE L/D RANGES FOR LOW-DISC-LOADING VTOL AIRCRAFT TYPES

REFERENCES

1. Kuhn, Richard E., An Investigation to Determine Conditions Under which Downwash from VTOL Aircraft will Start Surface Erosion from Various Types of Terrain, NASA TN D-56, 1959.
2. Pegg, Robert J., Damage Incurred on a Tilt-Wing Multipropeller VTOL/STOL Aircraft Operating over a Level, Gravel-Covered Surface, NASA TN D-535, December 1960.
3. O'Bryan, Thomas G., An Experimental Study of the Effect of Downwash from a Twin-Propeller VTOL Aircraft on Several Types of Ground Surfaces, NASA TN D-1239, May 1962.
4. O'Bryan, Thomas G., An Investigation of the Effect of Downwash from a VTOL Aircraft and a Helicopter in the Ground Environment, NASA TN D-977, October 1961.
5. Lichten, R. L., Helicopter Performance, Journal of the Aeronautical Sciences, July 1946.
6. Lynn, Robert R., Wing-Rotor Interactions, Journal of Aircraft, July-August 1966.
7. Cresap, W. L., Duhon, J. M., Lynn, R. R. and VanWyckhouse, J. F., The 200+ Knot Flight Research Helicopter, Presented at the American Helicopter Society National Forum, Washington, D. C., May 1965.
8. Lynn, R. R. and Drees, J. M., The Promise of Compounding, Journal of the American Helicopter Society, January 1967.
9. Sonneborn, W. G. O., High Mach Number, High Advance Ratio Flight Test Program with a UH-1 Compound Helicopter, U. S. Army Aviation Material Laboratories Report, to be published 1970.
10. Engle, F. V., Performance Comparisons of Compound Helicopter Propulsion Systems, Bell Memorandum Report 87:FVE: pam-988, 31 December 1969.
11. Lichten, R. L., Some Aspects of Convertible Aircraft Design, Journal of the Aeronautical Sciences, October 1949.
12. Young, A. M., Variable-Diameter Propeller, U. S. Patent 3,128,829, 14 April 1964.
13. Segel, Richard M. and Fradenburgh, Evan A., Development of the TRAC Variable-Diameter Rotor Concept, Sikorsky paper presented at the AIAA/AHS VTOL Research, Design and Operations Meeting, Atlanta, Georgia, February 17-19, 1969.
14. Deckert, W. H. and Ferry, R. G., Limited Flight Evaluation of the XV-3 Aircraft, TR-60-4, Air Force Flight Test Center, May 1960.
15. Drinkwater, F. J., III, Operation Technique for Transition of Several Types of V/STOL Aircraft, TND-774, NASA, March 1961.
16. Quigley, H. C. and Koenig, D. G., The Effect of Blade Flapping on the Dynamic Stability of a Tilting-Rotor Convertiplane, TND-778, NASA, April 1961.
17. Koenig, D. G., Grief, R. K., and Kelly, M. W., Full-Scale Wind-Tunnel Investigation of the Longitudinal Characteristics of a Tilting-Rotor Convertiplane, TN-D-35, NASA, December 1959.
18. Edenborough, H. Kipling, Investigation of Tilt-Rotor VTOL Aircraft Rotor-Pylon Stability, Journal of Aircraft, March-April 1968.
19. Gaffey, T. M., Yen, J. G., and Kvaternik, R. G., Analysis and Model Tests of the Proprotor Dynamics of a Tilt-Proprotor VTOL Aircraft, Presented at the Air Force V/STOL Technology and Planning Conference, Las Vegas, Nevada, September 23-25, 1969.
20. DeTore, J. A., Lift/Propulsion System Size-Selection Considerations for Stoppable Rotor VTOL Aircraft, Presented at the Air Force V/STOL Technology and Planning Conference, Las Vegas, Nevada, September 23-25, 1969.
21. Engle, F. V. and Sambell, K. W., Performance Aspects of Folding Proprotor V/STOL Aircraft, Presented at the American Helicopter Society National Forum, Washington, D. C., May 14-16, 1969.
22. Tiller, F. E., Jr. and Nicholson, Robert, Stability and Control Considerations for a Tilt-Fold-Proprotor Aircraft, Presented at the American Helicopter Society National Forum, Washington, D. C., June 1970.
23. Lichten, R. L., Graham, L. M., Wernicke, K. G. and Brown, E. L., A Survey of Low-Disc-Loading VTOL Aircraft Designs, Presented at the AIAA/RAES/JSASS Aircraft Design and Technology Meeting, Los Angeles, California, November 15-18, 1965.